

Balmoral









INSET ELECTRIC FIRE

BAL20BR



Balmoral Brass

Features

-  Unique Optiflame effect
-  2kW heat output
-  Choice of 2 heat settings
-  Thermostat
-  LED lighting
-  Side switch control
-  Coal fuel bed
-  Flame effect without heat

Balmoral



Brass

Spacer Kit



Manual Control



Fuel Bed



Balmoral

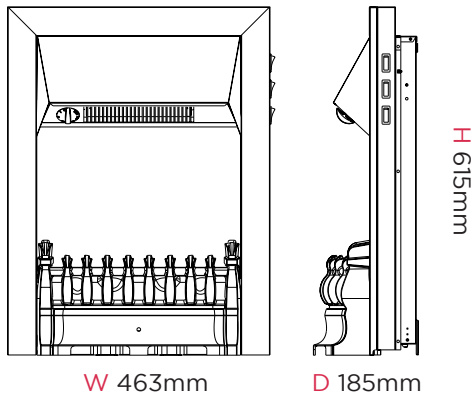

Dimensions & Weight

Height (mm)	Width (mm)	Depth (mm)	Weight (kg)
615	463	185	8

Product Features

Heat Output	2kW
Heat Settings	2 - 1kW / 2kW
Variable Thermostat	Y
Fan Heat / Radiant Heat	Yes / No
Location of Controls	On side panel
On/Off Switch	Y
Remote Control	N
Batteries Included	N
Optiflame Effect	Y
Flame Type	Rotisserie
Flame Effect Only	Y
Fuel Bed Supplied	Coal

Accessories

OSP004 Spacer Kit	X-048264
-------------------	----------

Product Features

Product Category	Electric Fires
Product Type	Inset
Brand	Dimplex
Model/Range Name	Balmoral
Flame Effect	Optiflame
Model Reference	BAL20BR
Material Code	X-047496
Barcode	5011139047496
Approvals	CE/UKCA
Guarantee Period	2 years

Product Features

Lot 20 Compliant	Y
Freestanding	Y (with spacer)
Wall Mountable	N
Inset	Y
Suite	N
Spacer Kit	Y (see below)
Lamp Type	LED
Safety Cut Out	Y
Kettle (IEC) Lead	Y
Power Cord Length	1.4m
Core Materials	Steel / Plastic
Finish / Colour	Brass